

COUPLED INDUCTORS, COMMON MODE CHOKES

SDRH5010D SERIES

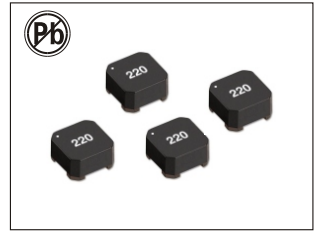

FEATURES:

- Only 1.0 mm high and 5 mm square
- Ideal for use in flyback, multi-output buck, SEPIC and Zeta applications
- High inductance, high efficiency and excellent current handling
- Can also be used as two single inductors connected in series or parallel or as a common mode choke
- UL Certified per File E219588

ELECTRICAL CHARACTERISTICS:

Part number SDRH5010D-	Inductance (uH) ± 20%	DCR max (Ohms)	SRF typ (Mhz)	Coupling coefficient typ	Leakage L typ (uH)	Isat (A)			Irms (A)	
						10% drop	20% drop	30% drop	both windings	one windings
R68N	0.68 ± 30%	0.07	191	0.95	0.07	2.6	2.7	2.8	1.95	2.76
1R0M	1.0	0.10	150	0.95	0.09	2.1	2.1	2.2	1.50	2.12
1R5M	1.5	0.15	134	0.97	0.09	1.7	1.8	1.8	1.20	1.70
2R2M	2.2	0.20	108	0.97	0.11	1.5	1.6	1.6	1.10	1.56
3R3M	3.3	0.27	83	0.98	0.13	1.2	1.3	1.3	0.95	1.34
4R7M	4.7	0.40	68	0.98	0.15	0.98	1.0	1.1	0.75	1.06
5R6M	5.6	0.45	60	0.99	0.16	0.90	0.93	0.94	0.70	0.99
6R8M	6.8	0.53	55	0.99	0.19	0.83	0.86	0.87	0.60	0.85
8R2M	8.2	0.70	50	0.99	0.22	0.74	0.77	0.78	0.50	0.71
100M	10	0.78	46	0.99	0.27	0.67	0.69	0.70	0.50	0.71
150M	15	1.19	33	0.99	0.34	0.53	0.55	0.56	0.42	0.59
220M	22	1.58	26	0.99	0.40	0.45	0.47	0.48	0.35	0.49
330M	33	2.50	23	0.99	0.48	0.37	0.38	0.39	0.30	0.42
470M	47	3.48	17.0	0.99	0.63	0.31	0.32	0.33	0.25	0.35
680M	68	5.10	14.9	0.99	0.90	0.25	0.26	0.27	0.19	0.26
101M	100	8.0	11.2	0.99	1.39	0.21	0.22	0.22	0.15	0.21
151M	150	11.7	9.90	0.99	2.10	0.17	0.17	0.18	0.12	0.16
221M	220	15.2	8.05	0.99	3.02	0.14	0.15	0.15	0.11	0.15

1. Inductance shown for each winding, measured at 100 kHz, 0.1 Vrms, 0 Adc on an Agilent/HP 4284A LCR meter or equivalent. When leads are connected in parallel, inductance is the same value. When leads are connected in series, inductance is four times the value
2. DCR is for each winding. When leads are connected in parallel, DCR is half the value. When leads are connected in series, DCR is twice the value
3. SRF measured using an Agilent/HP 4191A or equivalent. When leads are connected in parallel, SRF is the same value
4. Leakage Inductance is for L1 and is measured with L2 shorted
5. DC current at 25 °C that causes the specified inductance drop from its value without current. It is the sum of the current flowing in both windings
6. Equal current when applied to each winding simultaneously that causes a 40 °C temperature rise from 25 °C ambient. This information is for reference only and does not represent absolute maximum ratings
7. Maximum current when applied to one winding that causes a 40 °C temperature rise from 25 °C ambient. This information is for reference only and does not represent absolute maximum ratings
8. Electrical specifications at 25 °C
9. Ambient temperature -40 °C to +85 °C with (40 °C rise) Irms current
10. Maximum part temperature +125 °C (ambient + temp rise)
11. Storage temperature Component: -40 °C to +125 °C
12. Tape and reel packaging: -40 °C to +80 °C
13. Winding to winding isolation 100 Vrms, one minute
14. Resistance to soldering heat Max three 40 second reflows at +260 °C , parts cooled to room temperature between cycles
15. Packaging 1000/7 " reel; 3500/13 " reel

PHYSICAL CHARACTERISTICS & WINDING:

Dimensions are in mm

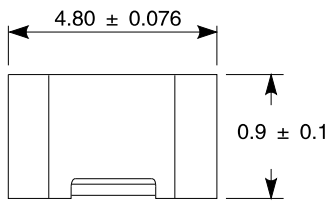
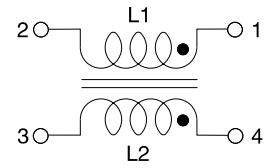
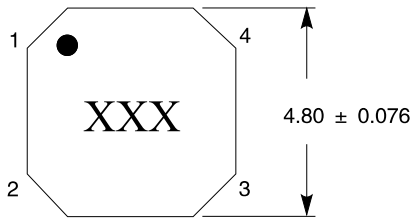

Recommended Land Pattern

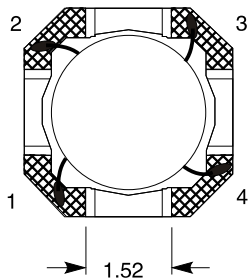
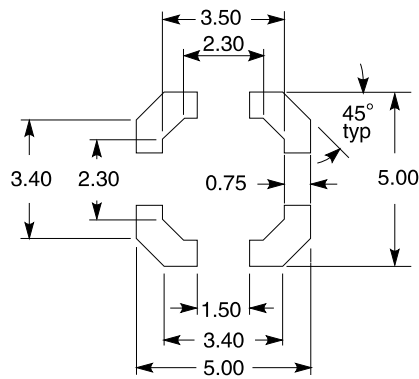

Dimensions are in mm

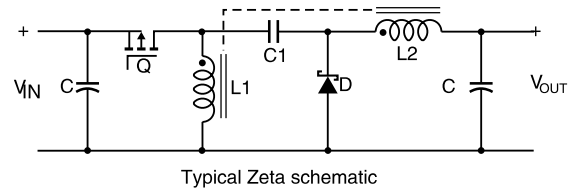
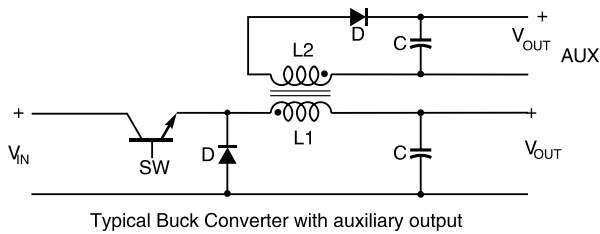
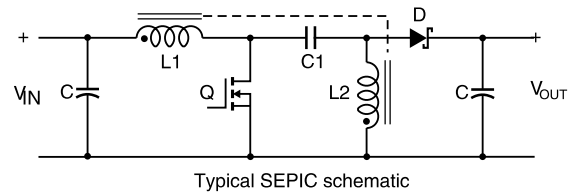
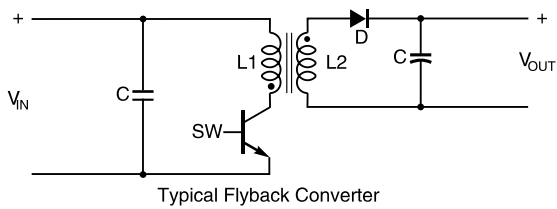

PERFORMANCE CURVE:

TYPICAL L VS CURRENT

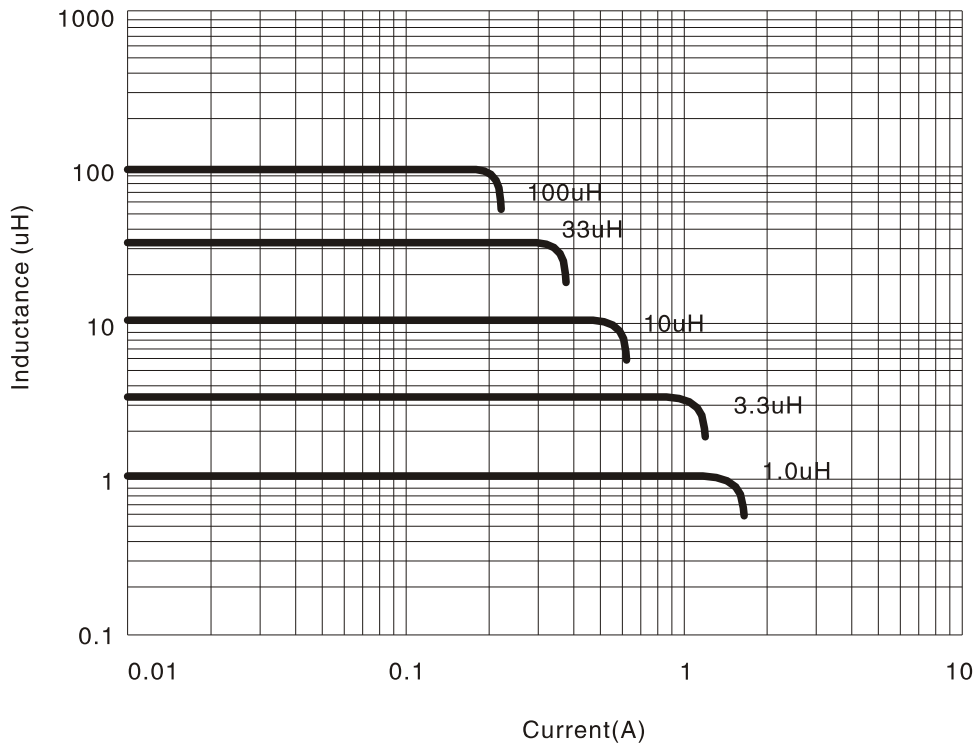

TYPICAL L VS FREQUENCY

